

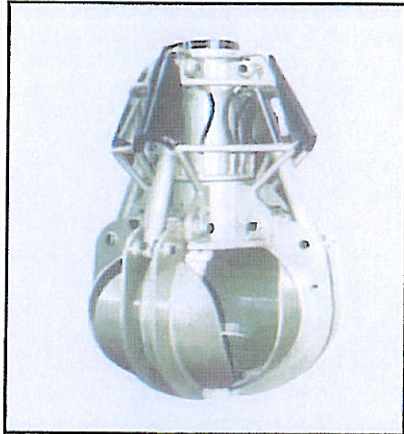

# ATLAS HIDRAULICA

## PULPO HIDRÁULICO MOD. FN



FN 25

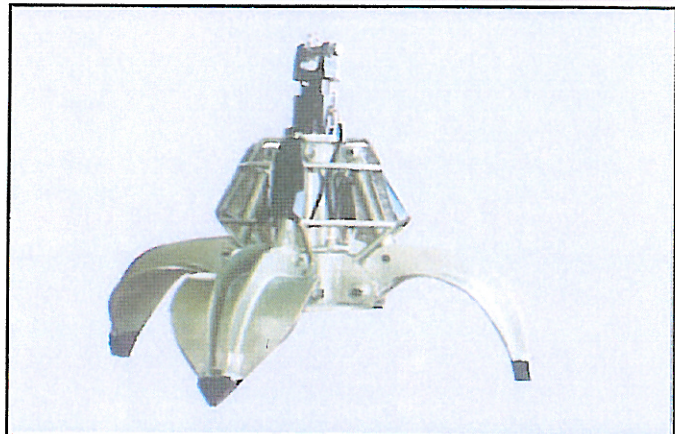

FN 25

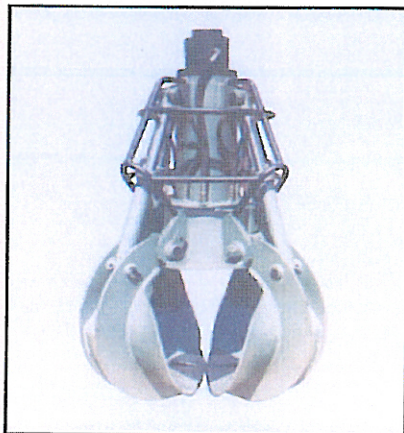

FN 50

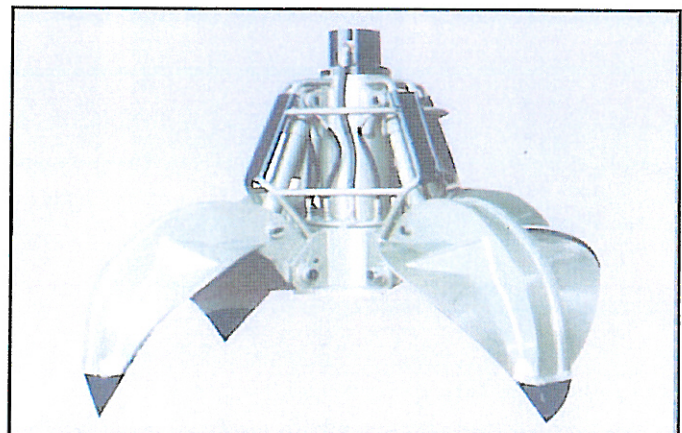

FN 50

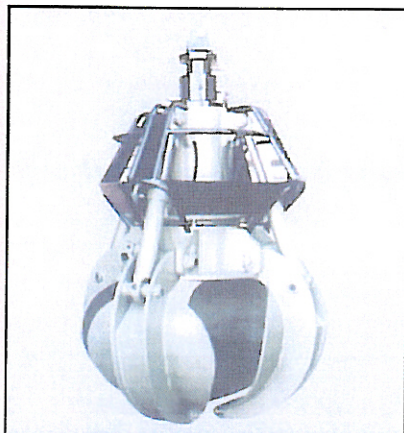

FN 75

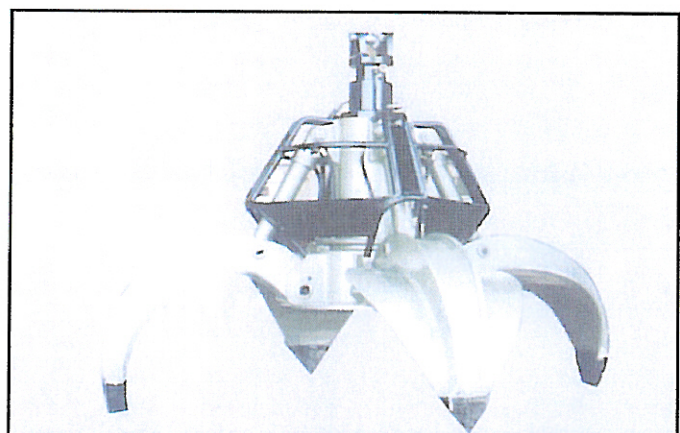

FN 75

Avda. Antoni Gaudí, 71-109, Nave 1, 08191 RUBÍ (BARCELONA)  
902 20 20 92  
Ctra. C-17, Km 50, 08550 TONA (BARCELONA)





SE PUEDE ADAPTAR:

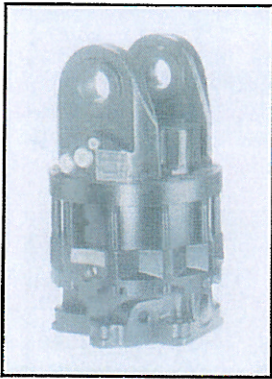

ROTATOR CONTINUO

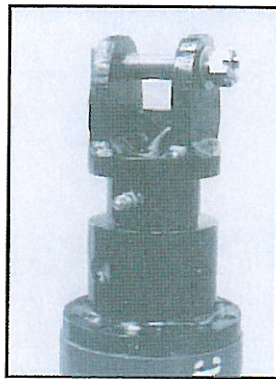

GIRO LOCO

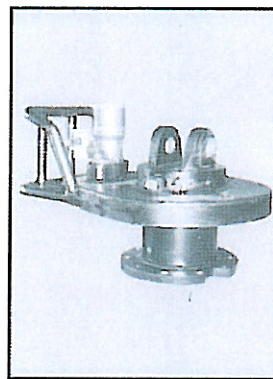



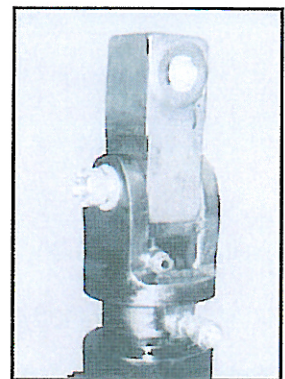

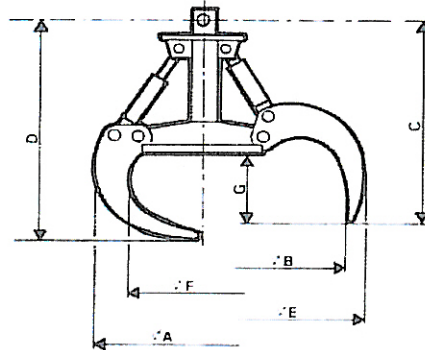

GIRO CONTROLADO CON MOTOR HIDRÁULICO



DADO DE ACOPLER

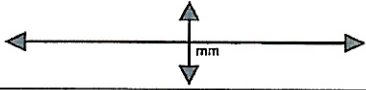

CARACTERÍSTICAS • TECHNISCHE DATEN • SCRAP HANDLER • CARACTERISTIQUES

													
							Ø A	Ø B	C	D	Ø E	Ø F	G
FN 75	500	350	4/5	1.400/5	1.800	360°	1.400	2.200	1.950	2.350	2.450	1.100	
FN 50	400	350	4/5	800/4	1.400	360°	1.250	2.000	1.400	1.800	2.250	920	
FN 25	300	350	4/5	490/4	1.200	360°	1.050	1.800	1.200	1.600	2.050	800	

Avda. Antoni Gaudí, 71-109, Nave 1, 08191 RUBÍ (BARCELONA)  
 902 20 20 92  
 Ctra. C-17, Km 50, 08550 TONA (BARCELONA)